

Diffuse Reflective Long-distance Photoelectric Sensors



BA Series PRODUCT MANUAL

For your safety, read and follow the considerations written in the instruction manual, other manuals and Autonics website.

The specifications, dimensions, etc. are subject to change without notice for product improvement. Some models may be discontinued without notice.

Features

- Realization of long sensing distance (2 m) by special optical design
- IP64 protection rating (IEC standard)
- Built-in stability indicator
- Sensitivity adjustment function
- 2 color display

Safety Considerations

- Observe all 'Safety Considerations' for safe and proper operation to avoid hazards.
- ⚠ symbol indicates caution due to special circumstances in which hazards may occur.

⚠ Warning Failure to follow instructions may result in serious injury or death.

- 01. Fail-safe device must be installed when using the unit with machinery that may cause serious injury or substantial economic loss. (e.g., nuclear power control, medical equipment, ships, vehicles, railways, aircraft, combustion apparatus, safety equipment, crime/disaster prevention devices, etc.)**
Failure to follow this instruction may result in personal injury, economic loss or fire.
- 02. Do not use the unit in the place where flammable/explosive/corrosive gas, high humidity, direct sunlight, radiant heat, vibration, impact or salinity may be present.**
Failure to follow this instruction may result in explosion or fire.
- 03. Do not disassemble or modify the unit.**
Failure to follow this instruction may result in fire.
- 04. Do not connect, repair, or inspect the unit while connected to a power source.**
Failure to follow this instruction may result in fire.
- 05. Check 'Connections' before wiring.**
Failure to follow this instruction may result in fire.

⚠ Caution Failure to follow instructions may result in injury or product damage.

- 01. Use the unit within the rated specifications.**
Failure to follow this instruction may result in fire or product damage.
- 02. Use a dry cloth to clean the unit, and do not use water or organic solvent.**
Failure to follow this instruction may result in fire.

Cautions during Use

- Follow instructions in 'Cautions during Use'. Otherwise, It may cause unexpected accidents.
- When connecting an inductive load such as DC relay or solenoid valve to the output, remove surge by using diodes or varistors.
- Use the product after 0.5 sec of the power input.
When using a separate power supply for the sensor and load, supply power to the sensor first.
- 12-24 VDC \equiv power supply should be insulated and limited voltage/current or Class 2, SELV power supply device.
- Wire as short as possible and keep it away from high voltage lines or power lines to prevent surge and inductive noise.
- When using switching mode power supply (SMPS), ground F.G. terminal and connect a condenser between 0V and F.G. terminal to remove noise.
- When using a sensor with a noise-generating equipment (e.g., switching regulator, inverter, and servo motor), ground F.G. terminal of the equipment.
- This unit may be used in the following environments.
 - Indoors (in the environment condition rated in 'Specifications')
 - Altitude max. 2,000 m
 - Pollution degree 3
 - Installation category II

Product Components

- Product
- Adjustment screwdriver
- Instruction manual

Ordering Information

This is only for reference, the actual product does not support all combinations. For selecting the specified model, follow the Autonics website.

BA 2M - D D T ① - ②

① Operation mode

No mark: Light ON
D: Dark ON

② Control output

No mark: NPN open collector output
P: PNP open collector output

Cautions during Installation

- Be sure to install this product by following the usage environment, location, and specified ratings. Consider the listed conditions below.
 - Installation environment and background (reflected light)
 - Sensing distance and sensing target
 - Direction of target's movement
 - Feature data
- When installing multiple sensors closely, it may result in malfunction due to mutual interference.
- For installation, tighten the screw with a torque of 0.5 N m.
- Do not impact with a hard object or bend the cable excessively. That could decrease the product's water resistance.
- Use this product after the test. Check whether the indicator works appropriately for the positions of the detectable object.

Reflective

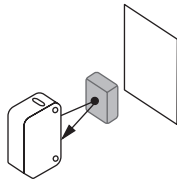

Sensor - Sensing target:
Install to face each other (parallel with the sensing side of the unit)

Operation Timing Chart

Light ON mode

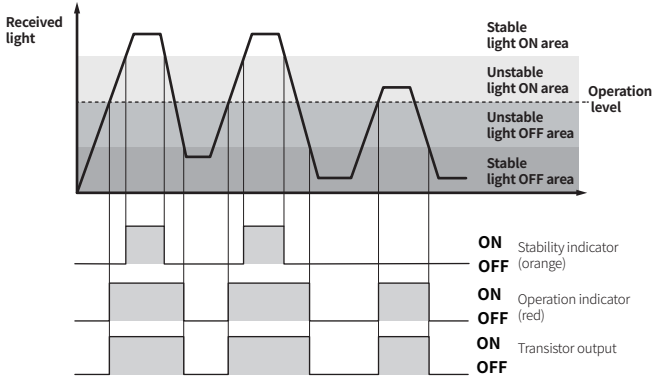

In Dark ON mode, the waveforms are reversed.

Connections

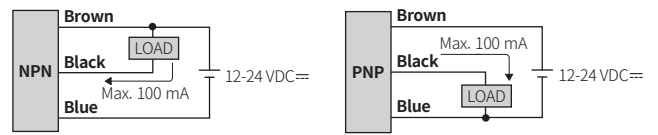

Circuit

NPN open collector output

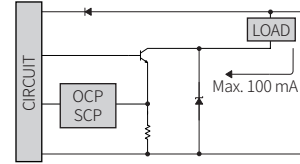

PNP open collector output

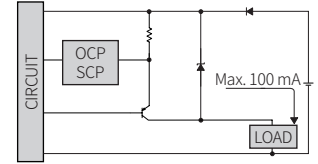

- OCP (over current protection), SCP (short circuit protection)
- If short-circuit the control output terminal or supply current over the rated specification, normal control signal is not output due to the protection circuit.

Sensitivity Adjustment

- Set the adjuster for stable Light ON area, minimizing the effect of the installation environment.
- Use the offered adjustment screwdriver. Do NOT turn with excessive force to prevent product damage.
- The steps below are based on Light ON mode.

STEP	Status	Description
01	Received	Turn the adjuster from MIN to MAX sensitivity and check the position (A) where the operation indicator activates under the light ON area.
02	Interrupted	Turn the adjuster from (A) to MAX and check the position (B) where the operation indicator activates under the light OFF area. If the operation indicator does NOT activate at the MAX (maximum sensitivity): MAX = (B).
03	-	Set the adjuster at the mid position between (A) and (B) for optimal sensitivity.

Dimensions

- Unit: mm, For the detailed drawings, follow the Autonics website.

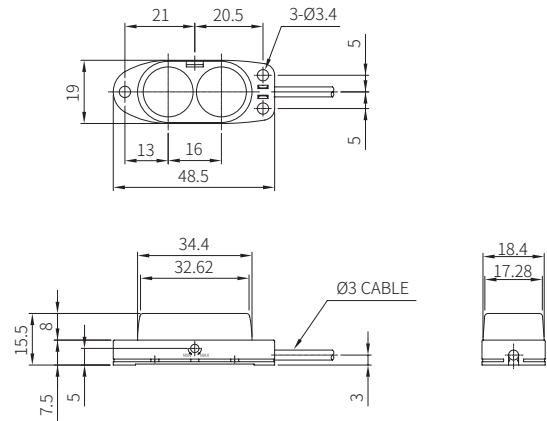

Specifications

Model	BA2M-DDT□-□
Sensing type	Diffuse reflective
Sensing distance	2 m ⁰¹⁾
Sensing target	Opaque materials, translucent materials
Hysteresis	≤ 20 % of sensing distance
Response time	≤ 1 ms
Light source	Infrared
Peak emission wavelength	850 nm
Sensitivity adjustment	YES (Adjuster)
Operation mode	Light ON mode / Dark ON mode model
Indicator	Operation indicator (red), stability indicator (Light ON: orange, Dark ON: green)
Approval	CE ENEC
Unit weight	≈ 50 g

01) Non-glossy white paper 200 × 200 mm

Power supply	12-24 VDC≐ ±10 % (ripple P-P: ≤ 10%)
Current consumption	≤ 15 mA (output ON: ≤ 30 mA)
Control output	NPN open collector output / PNP open collector output model
Load voltage	≤ 26.4 VDC≐
Load current	≤ 100 mA
Residual voltage	NPN: ≤ 1 VDC≐, PNP: ≤ 2.5 VDC≐
Protection circuit	Reverse power protection circuit, output short overcurrent protection circuit
Insulation resistance	≥ 20 MΩ (500 VDC≐ megger)
Noise immunity	±240 VDC≐ the square wave noise (pulse width: 1 μs) by the noise simulator
Dielectric strength	1,000 VAC~ 50/60 Hz for 1 min
Vibration	1.5 mm double amplitude at frequency of 10 to 55 Hz (for 1 min) in each X, Y, Z direction for 2 hours
Shock	100 m/s ² (≈ 10 G) in each X, Y, Z direction for 3 times
Ambient illuminance (receiver)	Sunlight: ≤ 11,000 lx, incandescent lamp: ≤ 3,000 lx
Ambient temperature	-25 to 55 °C, storage: -25 to 70 °C (no freezing or condensation)
Ambient humidity	35 to 85 %RH, storage: 35 to 85 %RH (no freezing or condensation)
Protection rating	IP64 (IEC standard)
Connection	Cable type
Cable spec.	Ø 3 mm, 3-wire, 2 m
Wire spec.	AWG24 (0.08 mm, 40-core), insulator outer diameter: Ø 1 mm
Material	Case: ABS, CAP: PC, sensing part: PC, adjuster: IXEF

Feature Data

■ Sensing area

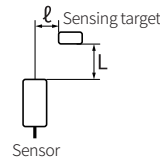

• BA2M-DDT

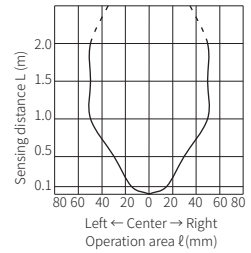

■ Sensing distance against the target size

• BA2M-DDT

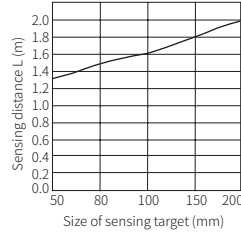

■ Sensing distance against the target color

• BA2M-DDT

