

# L 3.7 mm Flat Photoelectric Sensors



## BTF Series PRODUCT MANUAL

**For your safety, read and follow the considerations written in the instruction manual, other manuals and Autonics website.**

The specifications, dimensions, etc. are subject to change without notice for product improvement. Some models may be discontinued without notice.

### Features

- Ultra-thin size of only 3.7mm
  - W 13 × H 19 × L 3.7 mm (Through-beam type)
  - W 13 × H 24 × L 3.7 mm (Diffuse reflective type, BGS reflective type)
- Detection methods and minimum target size
  - Through-beam type (BTF1M): Ø 2 mm
  - Diffuse reflective type (BTF30): Ø 0.2 mm (sensing distance: 10 mm)
  - BGS reflective type (BTF15): Ø 0.2 mm (sensing distance: 10 mm)
- BGS (background suppression) minimizes detection errors from background objects and the color or material of target objects.
- Maximum sensing distance: 1 m (Through-beam type)
- Operation indicator (red) and stability indicator (green) show operation status
- Stainless steel (SUS304) mounting brackets
- IP67 protection rating (IEC standard)

### Safety Considerations

- Observe all 'Safety Considerations' for safe and proper operation to avoid hazards.
- ⚠ symbol indicates caution due to special circumstances in which hazards may occur.

**⚠ Warning** Failure to follow instructions may result in serious injury or death.

- 01. Fail-safe device must be installed when using the unit with machinery that may cause serious injury or substantial economic loss. (e.g., nuclear power control, medical equipment, ships, vehicles, railways, aircraft, combustion apparatus, safety equipment, crime/disaster prevention devices, etc.)**  
Failure to follow this instruction may result in personal injury, economic loss or fire.
- 02. Do not use the unit in the place where flammable/explosive/corrosive gas, high humidity, direct sunlight, radiant heat, vibration, impact or salinity may be present.**  
Failure to follow this instruction may result in explosion or fire.
- 03. Do not disassemble or modify the unit.**  
Failure to follow this instruction may result in fire.
- 04. Do not connect, repair, or inspect the unit while connected to a power source.**  
Failure to follow this instruction may result in fire.
- 05. Check 'Connections' before wiring.**  
Failure to follow this instruction may result in fire.

**⚠ Caution** Failure to follow instructions may result in injury or product damage.

- 01. Use the unit within the rated specifications.**  
Failure to follow this instruction may result in fire or product damage.
- 02. Use a dry cloth to clean the unit, and do not use water or organic solvent.**  
Failure to follow this instruction may result in fire.

### Cautions during Use

- Follow instructions in 'Cautions during Use'. Otherwise, It may cause unexpected accidents.
- When connecting an inductive load such as DC relay or solenoid valve to the output, remove surge by using diodes or varistors.
- Use the product after 0.1 sec of the power input.  
When using a separate power supply for the sensor and load, supply power to the sensor first.
- 12-24 VDC power supply should be insulated and limited voltage/current or Class 2, SELV power supply device.
- Wire as short as possible and keep it away from high voltage lines or power lines to prevent surge and inductive noise.
- When using switching mode power supply (SMPS), ground F.G. terminal and connect a condenser between 0V and F.G. terminal to remove noise.
- When using a sensor with a noise-generating equipment (e.g., switching regulator, inverter, and servo motor), ground F.G. terminal of the equipment.
- This unit may be used in the following environments.
  - Indoors (in the environment condition rated in 'Specifications')
  - Altitude max. 2,000 m
  - Pollution degree 3
  - Installation category II

### Product Components

Sensing type	Through-beam	Diffuse reflective	BGS reflective
<b>Product components</b>	Product, instruction manual		
Bracket	× 2	× 1	× 1
M2 bolt	× 4	× 2	× 2

## Ordering Information

This is only for reference, the actual product does not support all combinations. For selecting the specified model, follow the Autonics website.

**BTF** ① - ② **D T** ③ - ④

### ① Sensing distance

Number: Sensing distance (unit: mm)  
Number+M: Sensing distance (unit: m)

### ③ Operation mode

L: Light ON  
D: Dark ON

### ② Sensing type

T: Through-beam  
D: Diffuse reflective  
B: BGS reflective

### ④ Control output

No mark: NPN open collector output  
P: PNP open collector output

## Cautions during Installation

- Be sure to install this product by following the usage environment, location, and specified ratings. Consider the listed conditions below.
  - Installation environment and background (reflected light)
  - Sensing distance and sensing target
  - Direction of target's movement
  - Feature data
- When installing multiple sensors closely, it may result in malfunction due to mutual interference.
- BGS reflective: If the sensing target has a glossy surface or high reflection, tilt the sensor with an angle from 5 to 10 degrees and install it. Get rid of the effect of background object on the sensing performance.

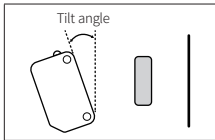

- For installation, tighten the screw with a torque of 0.3 N m. Mount the brackets correctly to prevent the twisting of the sensor's optical axis.
- Do not impact with a hard object or bend the cable excessively. That could decrease the product's water resistance.
- Use this product after the test. Check whether the indicator works appropriately for the positions of the detectable object.

Through-beam	Reflective
Emitter - Receiver: Install to face each other	Sensor - Sensing target: Install to face each other (parallel with the sensing side of the unit) BGS reflective: Recommend horizontal / back and force movements of sensing target

## Operation Timing Chart

### ■ Light ON mode

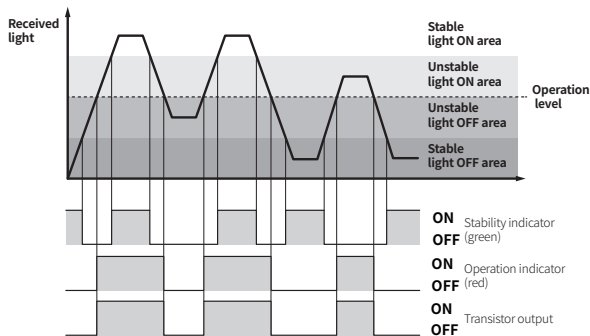

- In Dark ON mode, the waveforms are reversed.

## Connections

### ■ Emitter

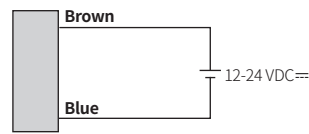

### ■ Receiver, Diffuse reflective, BGS reflective type

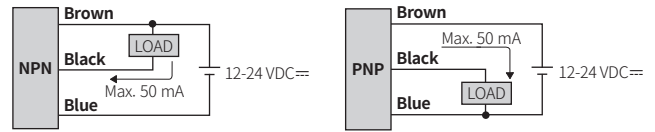

## Circuit

### ■ NPN open collector output

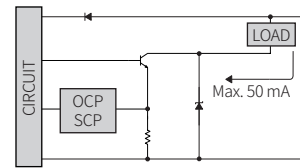

### ■ PNP open collector output

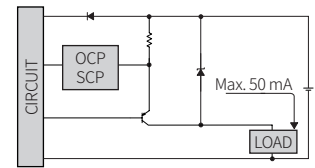

- OCP (over current protection), SCP (short circuit protection)
- If short-circuit the control output terminal or supply current over the rated specification, normal control signal is not output due to the protection circuit.

## Dimensions

- Unit: mm, For the detailed drawings, follow the Autonics website.

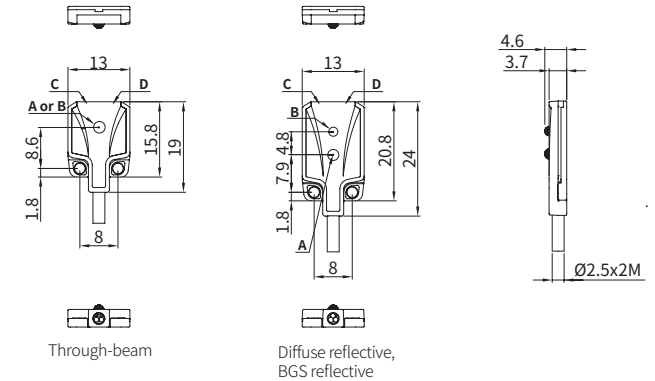

<b>A</b>	Optical axis of emitter	<b>C</b>	Operation indicator (red)
<b>B</b>	Optical axis of receiver	<b>D</b>	Stability indicator (green)

### ■ Bracket

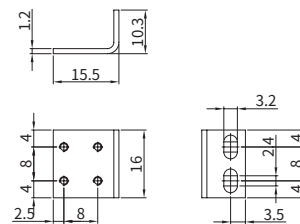

## Specifications

Model	BTF1M-TDT□-□	BTF30-DDT□-□	BTF15-BDT□-□
Sensing type	Through-beam	Diffuse reflective	BGS reflective
Sensing distance	1 m	5 to 30 mm <sup>(01)</sup>	1 to 15 mm <sup>(01)</sup>
Sensing target	Opaque materials	Opaque materials, translucent materials	Opaque materials, translucent materials
Min. sensing target	≥ Ø 2 mm	≥ Ø 0.2 mm <sup>(02)</sup>	≥ Ø 0.2 mm non-illuminated objects <sup>(02)</sup>
Hysteresis	-	≤ 20% of sensing distance	≤ 5% of sensing distance
Black/white difference	-	-	≤ 15% of sensing distance
Response time	≤ 1 ms		
Light source	Red		
Peak emission wavelength	650 nm		
Operation mode	Light ON mode / Dark ON mode model		
Indicator	Operation indicator (red), stability indicator (green)		
Approval	CE ENEC	CE ENEC	CE ENEC
Unit weight (packaged)	≈ 40 g (≈ 70 g)	≈ 25 g (≈ 40 g)	≈ 25 g (≈ 40 g)

01) Non-glossy white paper 50 × 50 mm

02) Sensing distance 10 mm

Power supply	12-24 VDC ≐ ±10% (ripple P-P: ≤ 10%)
Current consumption	It depends on the sensing type
Through-beam	Emitter: ≤ 20 mA, receiver: ≤ 20 mA
Reflective	≤ 20 mA
Control output	NPN open collector output / PNP open collector output model
Load voltage	≤ 26.4 VDC ≐
Load current	≤ 50 mA
Residual voltage	NPN: ≤ 1 VDC ≐, PNP: ≤ 2 VDC ≐
Protection circuit	Reverse power protection circuit, output short overcurrent protection circuit
Insulation resistance	≥ 20 MΩ (500 VDC ≐ megger)
Noise immunity	±240 VDC ≐ the square wave noise (pulse width: 1 μs) by the noise simulator
Dielectric strength	1,000 VAC ~ 50/60 Hz for 1 min
Vibration	1.5 mm double amplitude at frequency of 10 to 55 Hz (for 1 min) in each X, Y, Z direction for 2 hours
Shock	500 m/s <sup>2</sup> (≈ 50 G) in each X, Y, Z direction for 3 times
Ambient illuminance (receiver)	Sunlight: ≤ 10,000 lx, incandescent lamp: ≤ 3,000 lx
Ambient temperature	-25 to 55 °C, storage: -40 to 70 °C (no freezing or condensation)
Ambient humidity	35 to 85 %RH, storage: 35 to 85 %RH (no freezing or condensation)
Protection rating	IP67 (IEC standard)
Connection	Cable type
Cable spec.	Ø 2.5 mm, 3-wire (emitter: 2-wire), 2 m
Wire spec.	AWG 28 (0.08 mm, 19-core), insulator outer diameter: Ø 0.9 mm
Material	Case: PBT, sensing part: PMMA, bracket: SUS304, bolt: carbon steel, sleeve: SUS304

## Feature Data: Through-beam Type

### ■ Sensing area

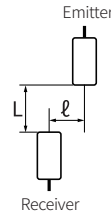

• BTF1M-TDTL

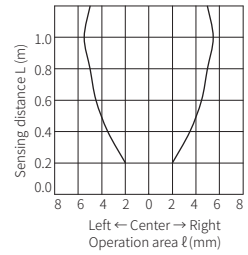

### ■ Emitter angle

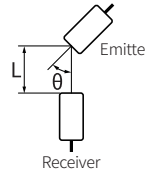

• BTF1M-TDTL

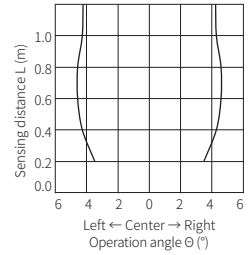

## Feature Data: Diffuse Reflective Type

### ■ Sensing area

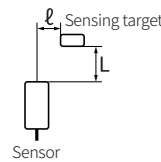

• BTF30-DDTL

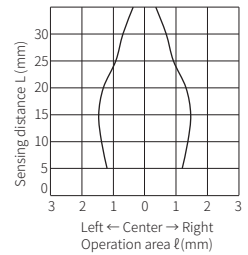

## Feature Data: BGS Reflective Type

### ■ Sensing area

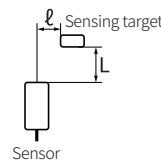

• BTF15-BDTL

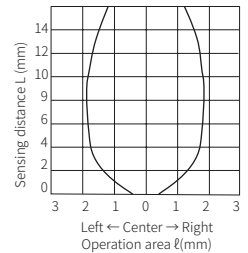

### ■ Sensing distance by material

• BTF15-BDTL

