

Rectangular Inductive Proximity Sensors



PS Series (DC 2-wire) PRODUCT MANUAL

For your safety, read and follow the considerations written in the instruction manual, other manuals and Autonics website.

The specifications, dimensions, etc. are subject to change without notice for product improvement. Some models may be discontinued without notice.

Features

- Operation indicator (red LED)
- IP67 protection structure (IEC standard)

Safety Considerations

- Observe all 'Safety Considerations' for safe and proper operation to avoid hazards.
- ⚠ symbol indicates caution due to special circumstances in which hazards may occur.

⚠ Warning Failure to follow instructions may result in serious injury or death.

- 01. Fail-safe device must be installed when using the unit with machinery that may cause serious injury or substantial economic loss. (e.g. nuclear power control, medical equipment, ships, vehicles, railways, aircraft, combustion apparatus, safety equipment, crime/disaster prevention devices, etc.)**
Failure to follow this instruction may result in personal injury, economic loss or fire.
- 02. Do not use the unit in the place where flammable/explosive/corrosive gas, high humidity, direct sunlight, radiant heat, vibration, impact, or salinity may be present.**
Failure to follow this instruction may result in explosion or fire.
- 03. Do not disassemble or modify the unit.**
Failure to follow this instruction may result in fire.
- 04. Do not connect, repair, or inspect the unit while connected to a power source.**
Failure to follow this instruction may result in fire.
- 05. Check 'Connections' before wiring.**
Failure to follow this instruction may result in fire.

⚠ Caution Failure to follow instructions may result in injury or product damage.

- 01. Use the unit within the rated specifications.**
Failure to follow this instruction may result in fire or product damage.
- 02. Use a dry cloth to clean the unit, and do not use water or organic solvent.**
Failure to follow this instruction may result in fire.
- 03. Do not supply power without load.**
Failure to follow this instruction may result in fire or product damage.

Cautions during Use

- Follow instructions in 'Cautions during Use'. Otherwise, it may cause unexpected accidents.
- 12-24 VDC \equiv power supply should be insulated and limited voltage/current or Class 2, SELV power supply device.
- Use the product, after 0.8 sec of supplying power.
- Wire as short as possible and keep away from high voltage lines or power lines, to prevent surge and inductive noise. Do not use near the equipment which generates strong magnetic force or high frequency noise (transceiver, etc.).
In case installing the product near the equipment which generates strong surge (motor, welding machine, etc.), use diode or varistor to remove surge.
- This unit may be used in the following environments.
 - Indoors (in the environment condition rated in 'Specifications')
 - Altitude max. 2,000 m
 - Pollution degree 2
 - Installation category II

Cautions for Installation

- Install the unit correctly with the usage environment, location, and the designated specifications.
- Do NOT impacts with a hard object or excessive bending of the wire lead-out. It may cause damage the water resistance.
- Do NOT pull the \varnothing 4 mm cable with a tensile strength of 30 N or over.
It may result in fire due to the broken wire.
- When extending wire, use AWG 22 cable or over within 200 m.
- Tighten the installing screw with under 0.49 N m tightening torque when mounting the bracket.

Ordering Information

This is only for reference, the actual product does not support all combinations.
For selecting the specified model, follow the Autonics website.

PSNT 17 - 5 D ① ②

① Control output

O: Normally Open
C: Normally Closed

② Sensing side

No-mark: Standard type
U: Upper side type

Product Components

- Bracket × 1
- M3 Blot × 2

Connections

- LOAD can be wired to any direction.
- Connect LOAD before supplying the power.

■ Cable type

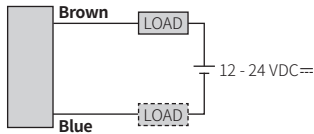

■ Inner circuit

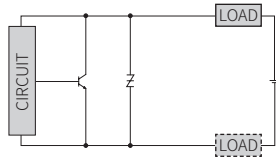

Operation Timing Chart

	Normally open	Normally closed
Sensing target	Presence Nothing	Presence Nothing
Load	Operation Return	Operation Return
Operation indicator (red)	ON OFF	ON OFF

Specifications

Installation	Standard type / Upper side type
Model	PSNT17-5D□□
Sensing side length	18 mm
Sensing distance	5 mm
Setting distance	0 to 3.5 mm
Hysteresis	≤ 10 % of sensing distance
Standard sensing target: iron	18 × 18 × 1 mm
Response frequency⁰¹⁾	700 Hz
Affection by temperature	± 10 % for sensing distance at ambient temperature 20 °C
Indicator	Operation indicator (red)
Approval	CE [E]
Unit weight (≈ 58 g (≈ 79 g)

01) The response frequency is the average value. The standard sensing target is used and the width is set as 2 times of the standard sensing target, 1/2 of the sensing distance for the distance.

Power supply	12 - 24 VDC (ripple P-P: ≤ 10 %), operating voltage: 10 - 30 VDC
Leakage current	≤ 0.6 mA
Control output	2 to 100 mA
Residual voltage	≤ 3.5 V
Protection circuit	Surge protection circuit, output short over current protection circuit, reverse polarity protection
Insulation type	≥ 50 MΩ (500 VDC megger)
Dielectric strength	1,500 VAC ~ 50 / 60 Hz for 1 min (between all terminals and case)
Vibration	1 mm double amplitude at frequency 10 to 55 Hz (for 1 min) in each X, Y, Z direction for 2 hours
Shock	500 m/s ² (≈ 50 G) in each X, Y, Z direction for 3 times
Ambient temperature	-25 to 70 °C, storage: -30 to 80 °C (no freezing or condensation)
Ambient humidity	35 to 95 %RH, storage: 35 to 95 %RH (no freezing or condensation)
Protection structure	IP67 (IEC standards)
Connection	Cable type model
Wire spec.	Ø 4 mm, 2-wire, 2 m
Connector spec.	AWG 22 (0.08 mm, 60-core), insulator diameter: Ø 1.25 mm
Material	Case: PBT, standard type cable (black): polyvinyl chloride (PVC)

Dimensions

• Unit: mm, For the detailed dimensions of the product, follow the Autonics web site.

A	Operation indicator (red)	B	Tap hole
----------	---------------------------	----------	----------

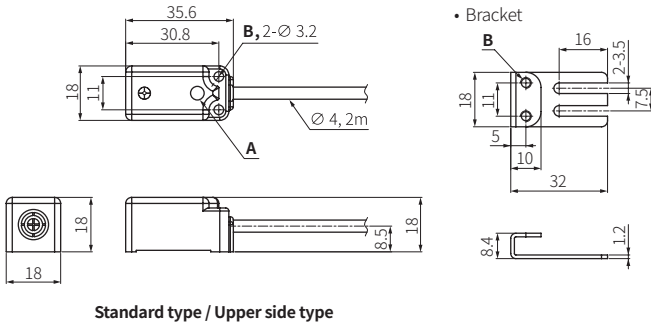

Setting Distance Formula

Detecting distance can be changed by the shape, size or material of the target.

For stable sensing, install the unit within the 70% of sensing distance.

Setting distance (Sa)
= Sensing distance (Sn) × 70%

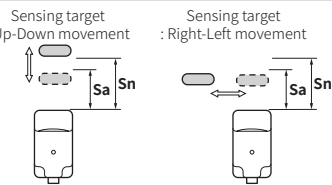

Mutual-interference & Influence by Surrounding Metals

■ Mutual-interference

When plural proximity sensors are mounted in a close row, malfunction of sensor may be caused due to mutual interference.

Therefore, be sure to provide a minimum distance between the two sensors, as below table.

A	30 mm	B	36 mm
----------	-------	----------	-------

[Face to Face]

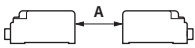

[Parallel]

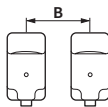

■ Influence by surrounding metals

When sensors are mounted on metallic panel, it must be prevented sensors from being affected by any metallic object except target. Therefore, be sure to provide a minimum distance as below chart.

c	4 mm	d	15 mm	m	18 mm
----------	------	----------	-------	----------	-------

• Standard type

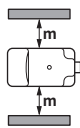
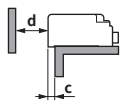

• Upper side type

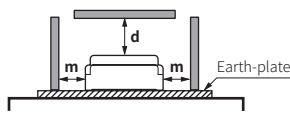

Sensing Distance Feature Data by Target Material and Size

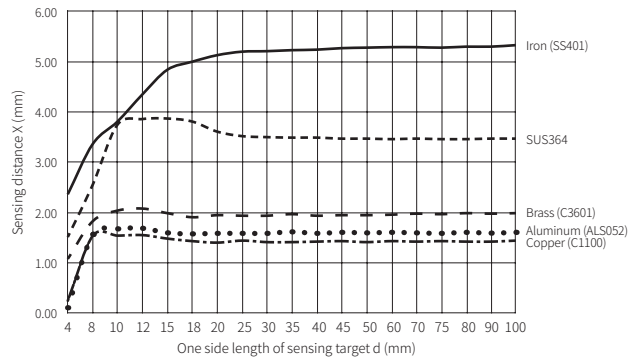
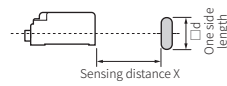

Sensing Distance Feature Data by Parallel (Left/Right) Movement

